

Applications

- Point-to-Point Radio
- K-band Sat-Com



28 lead 5x5mm QFN package

Product Features

- Frequency Range: 24.2 – 26.5 GHz
- Power: 34 dBm Psat, 33 dBm P1dB
- Gain: 18 dB
- TOI: 43 dBm at 23 dBm/tone
- Integrated Power Detector
- Bias: $V_d = 6\text{ V}$, $I_{dq} = 1430\text{ mA}$, $V_g = -0.7\text{ V}$ Typical
- Package Dimensions: 5.0 x 5.0 x 1.3 mm

General Description

The TriQuint TGA4536-SM is a K-Band Power Amplifier with integrated power detector. The TGA4536-SM operates from 24.2 – 26.5 GHz and is designed using TriQuint's power pHEMT production process.

The TGA4536-SM typically provides 34 dBm of saturated output power with small signal gain of 18 dB. Third Order Intercept is 43 dBm at 23 dBm SCL.

The TGA4536-SM is available in a low-cost, surface mount 28 lead 5x5 QFN package and is ideally suited for Point-to-Point Radio.

Lead-free and RoHS compliant

Evaluation Boards are available upon request.

Functional Block Diagram

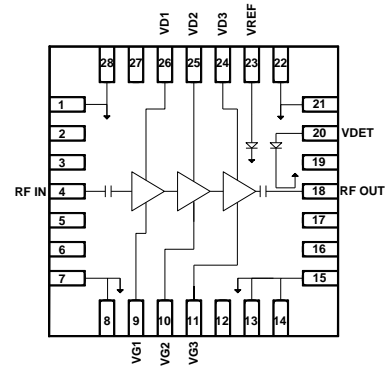

Pin Configuration

Pin No.	Label
1,7,8,13,14,15, 21,22,28,29	GND
2,3,5,6,12,16, 17,19,20,27	N/C
4	RF IN
9	VG1
10	VG2
11	VG3
18	RF OUT
20	VDET
23	VREF
24	VD3
25	VD2
26	VD1

Ordering Information

Part No.	ECCN	Description
TGA4536-SM	3A001.b.2.c	K-Band Power Amplifier
Standard T/R size = 500 pieces on a 7" reel		

Absolute Maximum Ratings

Parameter	Rating
Drain Voltage, Vd	6.5 V
Gate Voltage, Vg	-3 to 0 V
Drain to Gate Voltage, Vd – Vg	10 V
Drain Current, Id	3.0 A
Gate Current, Ig	-14 to +110 mA
Power Dissipation, Pdiss	20 W
RF Input Power, CW, T = 25 °C	25 dBm
Channel Temperature, Tch	200 °C
Mounting Temperature (30 sec)	260 °C
Storage Temperature	-40 to 150 °C

Operation of this device outside the parameter ranges given above may cause permanent damage.

Recommended Operating

Parameter	Min	Typ	Max	Units
Operating Temp. Range	-40		+85	°C
Vd		6.0		V
Idq		1430		mA
Id_drive (at P1dB)		2000		mA
Vg		-0.7		V
Ig_drive (Under RF Drive)		25		mA

Electrical specifications are measured at specified test conditions. Specifications are not guaranteed over all recommended operating conditions.

Electrical Specifications

Test conditions unless otherwise noted: Vd = +6 V, Idq = 1430 mA, Vg = -0.7 V, Temp = +25°C, Z₀ = 50 Ω

Parameter	Conditions	Min	Typ	Max	Units
Operational Frequency Range		24.2		26.5	GHz
Gain			18		dB
Input Return Loss			9		dB
Output Return Loss			10		dB
Output Power @ Saturation			34		dBm
Output Power @ 1 dB Gain Compression			33		dBm
Output TOI @ 23 dBm/Tone Pout/tone			43		dBm
Gain Temperature Coefficient			-0.02		dB/°C
Power Temperature Coefficient			-0.005		dBm/°C

Specifications

Thermal and Reliability Information

Parameter	Conditions	Rating
Thermal Resistance, θ_{JC} , measured to back of package	Tbase = 85 °C	$\theta_{JC} = 5.75 \text{ }^\circ\text{C/W}$
Channel Temperature (Tch), and Median Lifetime (Tm)	Tbase = 85 °C Vd = 6 V Id = 1430 mA Pdiss = 8.6 W	Tch = 134 °C Tm = 6.6E+6 Hours
Channel Temperature (Tch), and Median Lifetime (Tm) Under RF Drive	Tbase = 85 °C Vd = 6 V Id = 2100 mA Pout = 34.2 dBm Pdiss = 10 W	Tch = 143 °C Tm = 2.4E+6 Hours

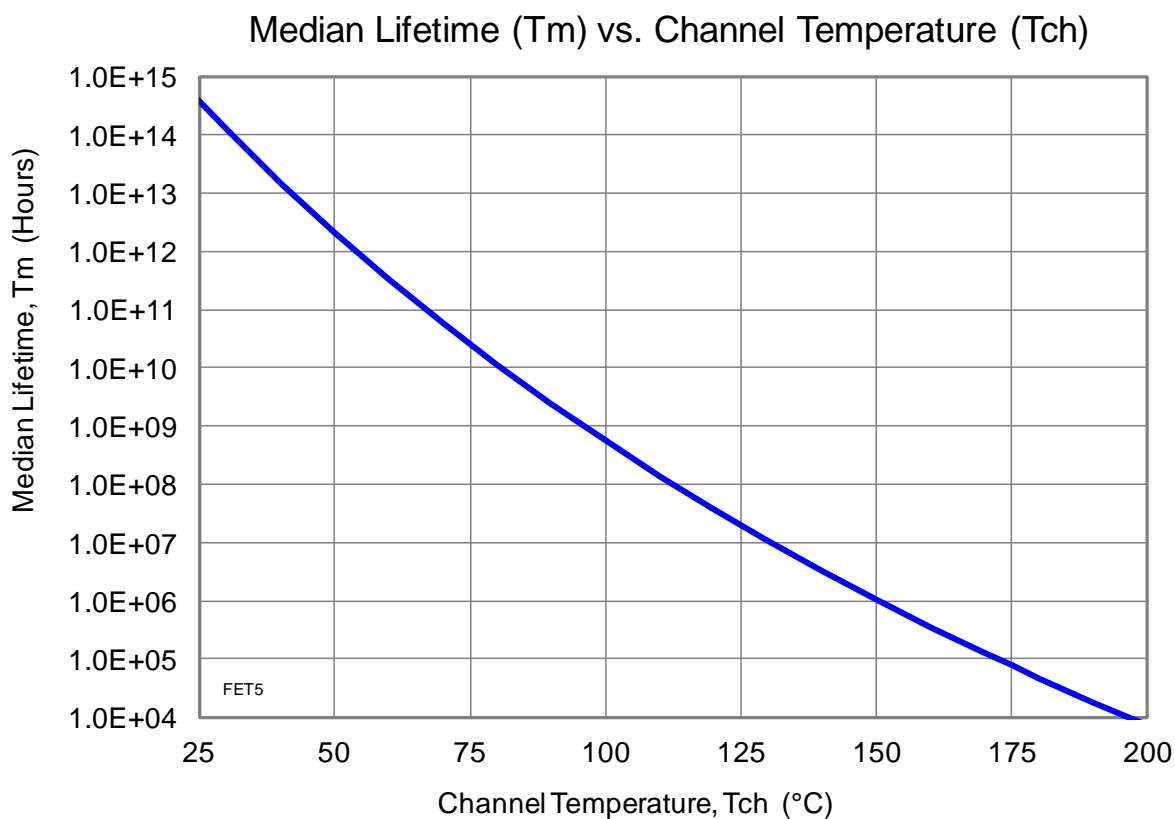

Typical Performance

Test conditions unless otherwise noted: $V_d = +6\text{ V}$, $V_g = -0.7\text{ V}$, $I_{dq} = 1430\text{ mA}$, Temperature = $+25\text{ }^\circ\text{C}$

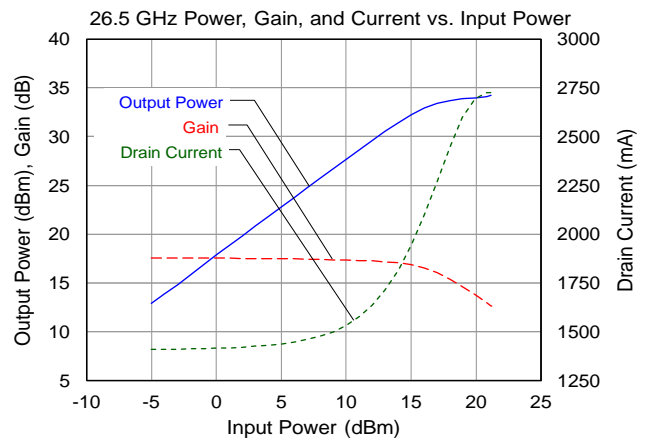
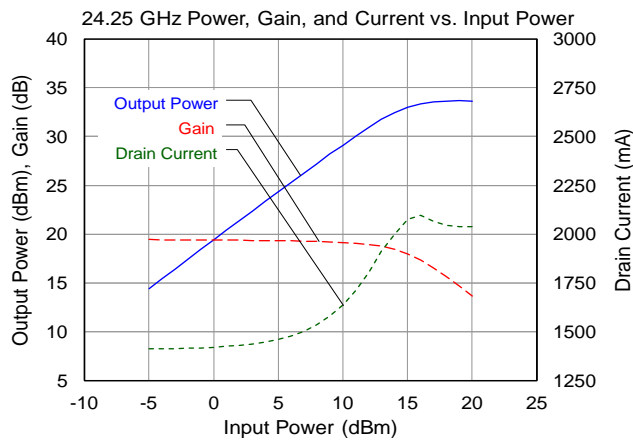
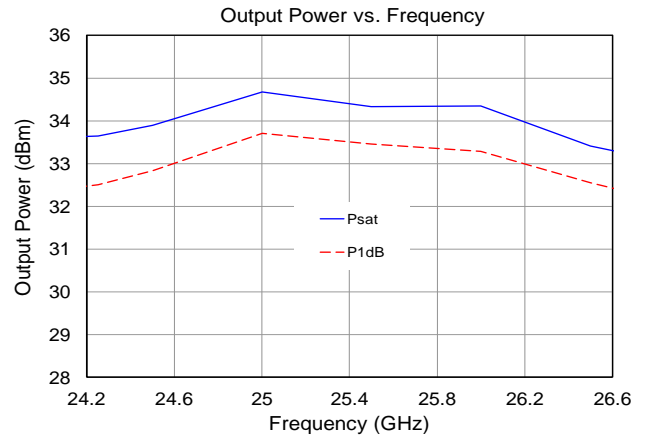
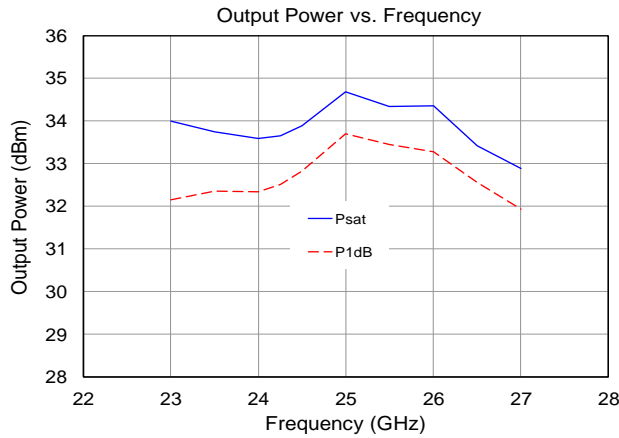
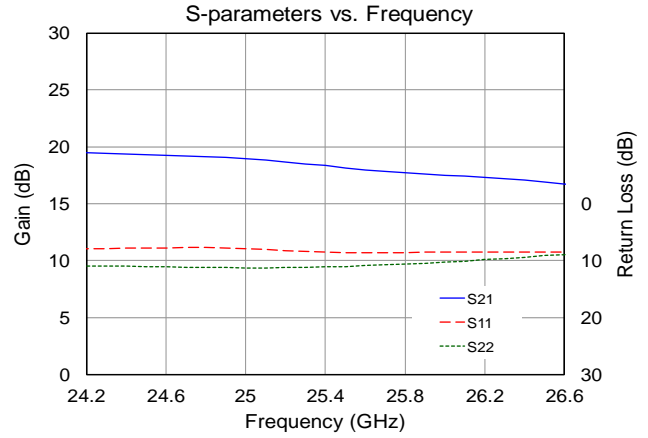
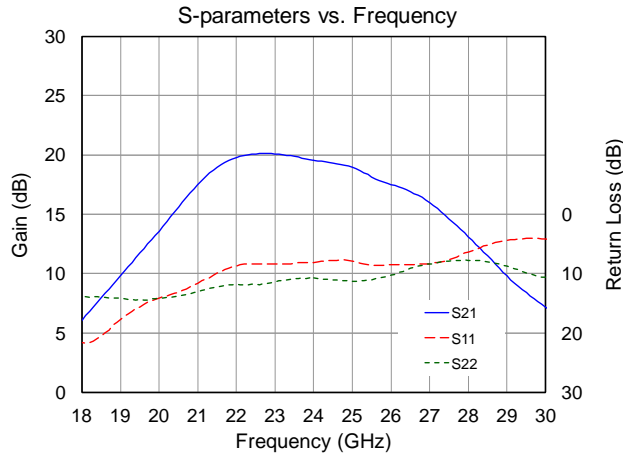

Typical Performance

Test conditions unless otherwise noted: $V_d = +6\text{ V}$, $V_g = -0.7\text{ V}$, $I_{dq} = 1430\text{ mA}$, Temperature = $+25\text{ }^\circ\text{C}$

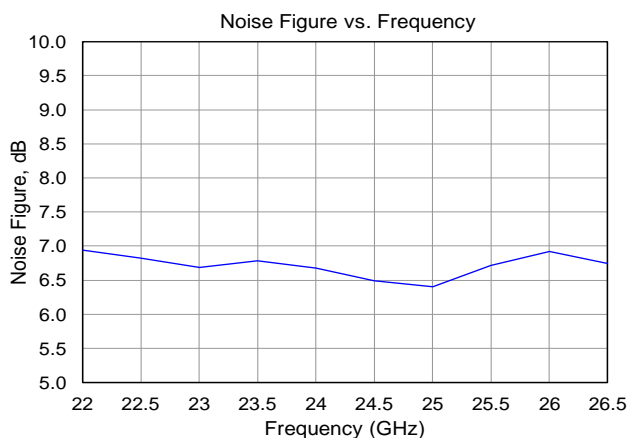
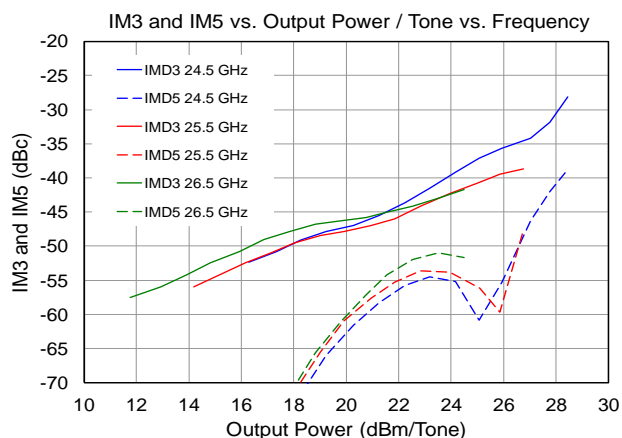
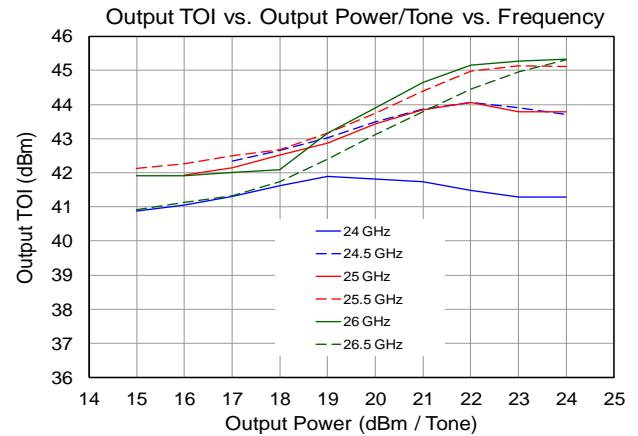
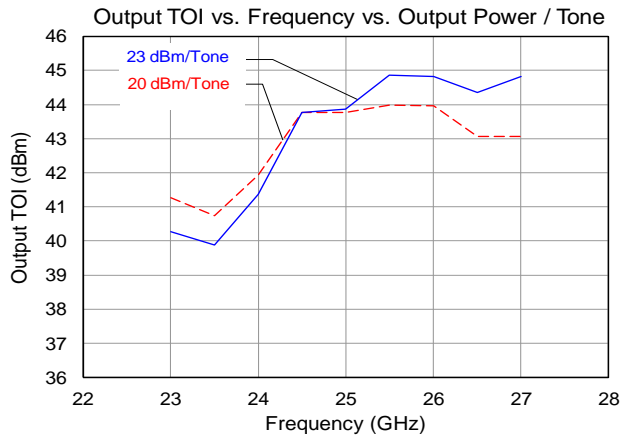
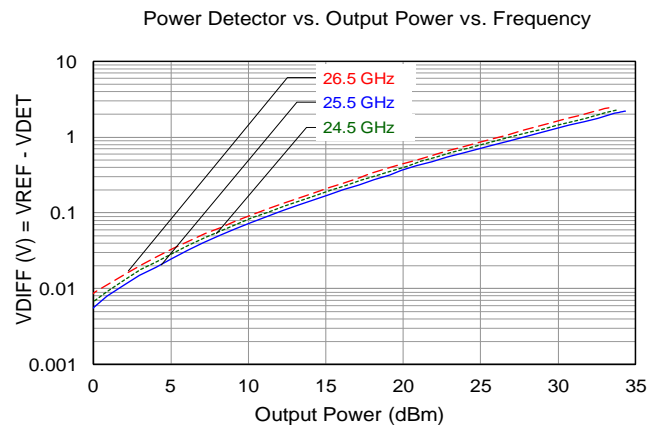
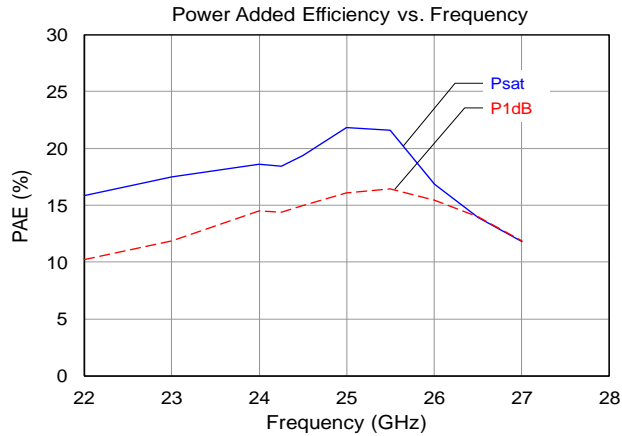

Typical Performance

Test conditions unless otherwise noted: $V_d = +6\text{ V}$, $V_g = -0.7\text{ V}$, $I_{dq} = 1430\text{ mA}$, Temperature = $+25\text{ }^\circ\text{C}$

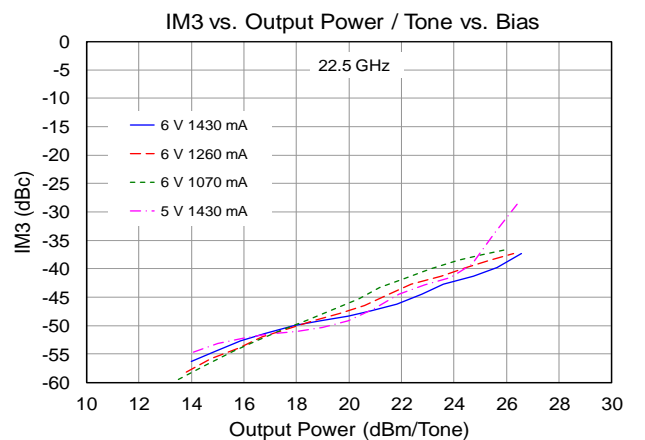
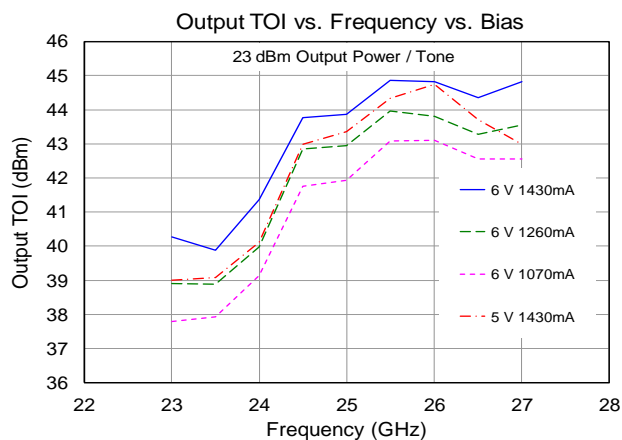
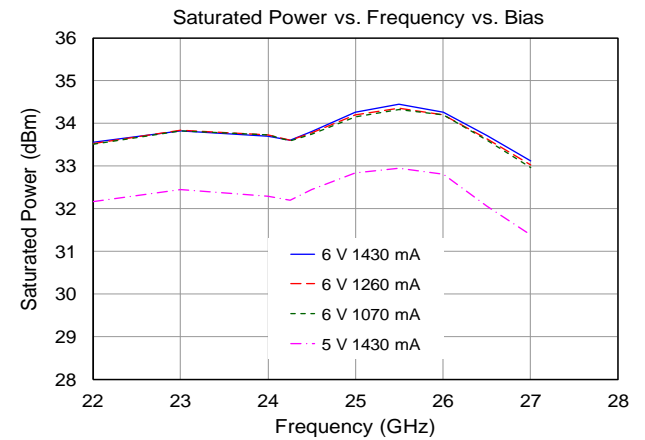
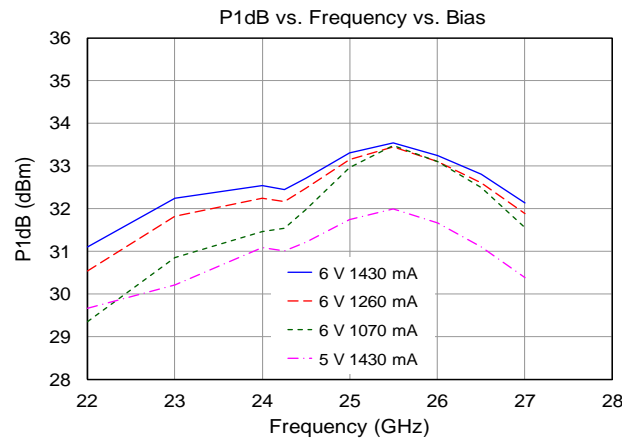
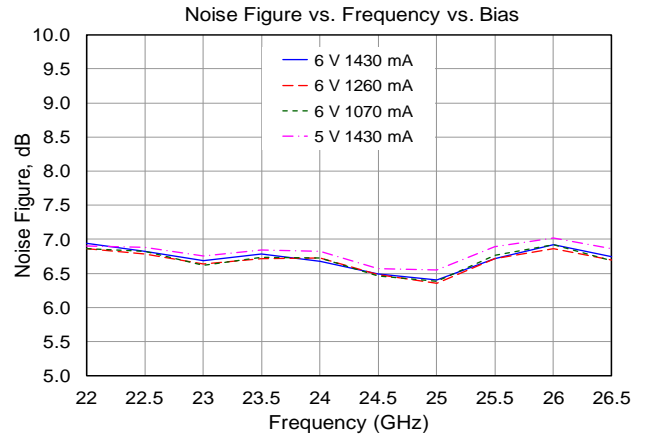
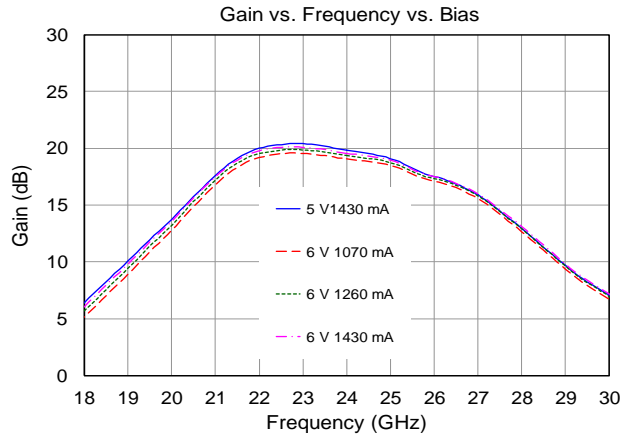

Typical Performance

Test conditions unless otherwise noted: $V_d = +6\text{ V}$, $V_g = -0.7\text{ V}$, $I_{dq} = 1430\text{ mA}$, Temperature as noted

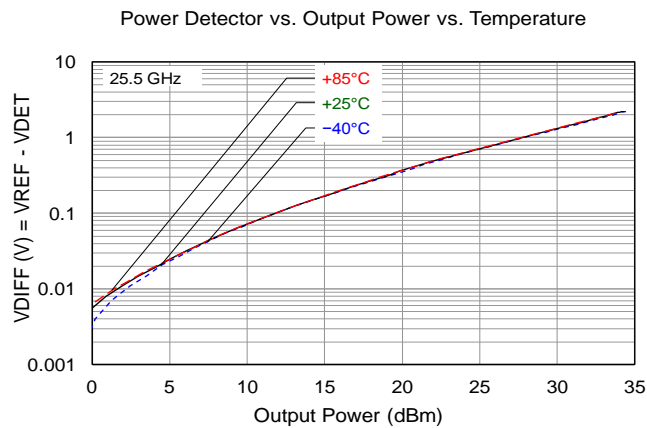
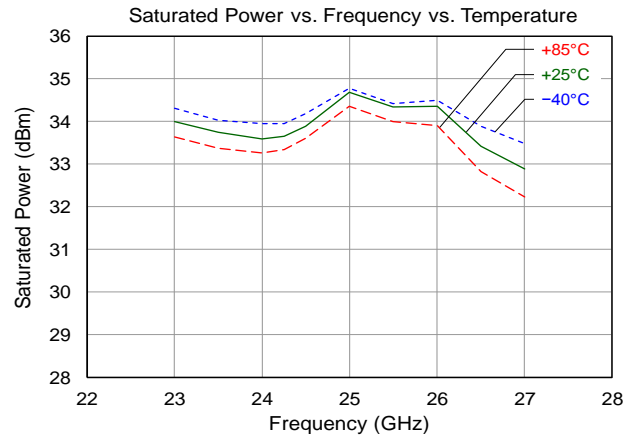
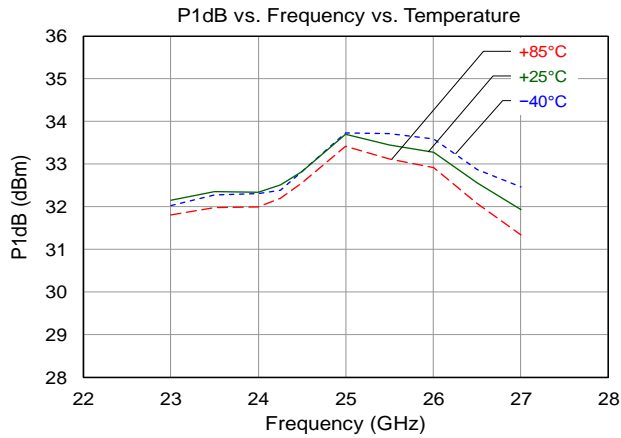
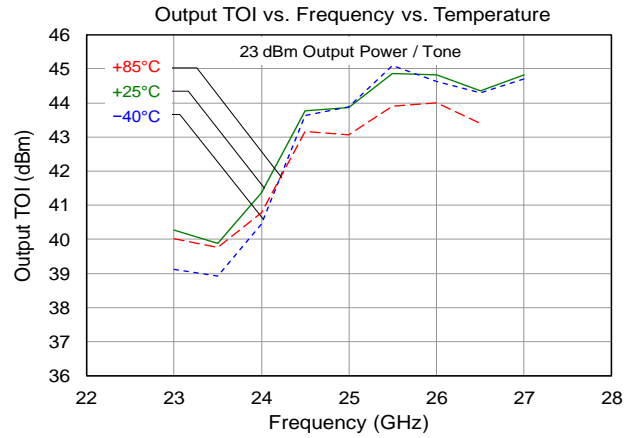
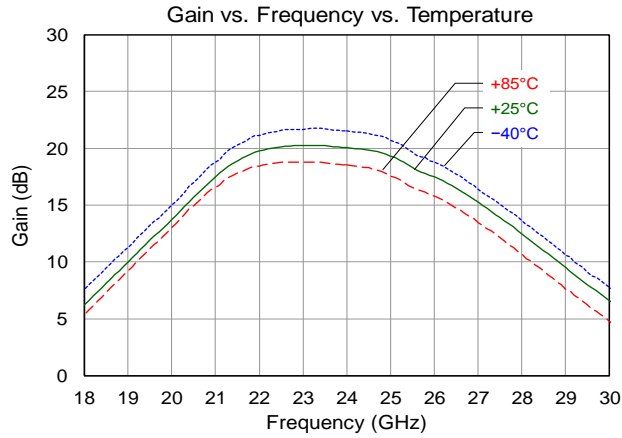

Pin Configuration and Description

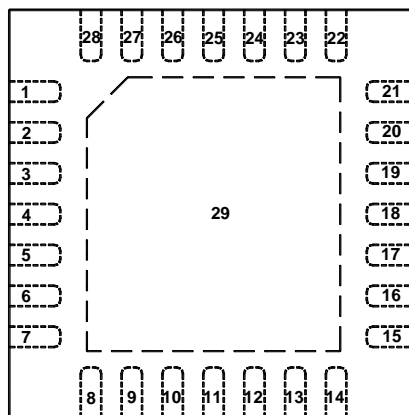

Pin No.	Label	Description
1,7,8,14,15,21,22,28,29	GND	Backside paddle. Multiple vias should be employed to minimize inductance and thermal resistance; see 'PCB Mounting Pattern' on page 12 for suggested footprint
2,3,5,6,16,17,19,20	N/C	No internal connection; Recommend grounding these pins for best RF performance. See 'PCB Mounting Pattern' on page 12 for suggested footprint
4	RF IN	RF input, matched to 50 ohms
9	VG1	Stage 1 gate voltage ⁽¹⁾
10	VG2	Stage 2 gate voltage ⁽¹⁾
11	VG3	Stage 3 gate voltage ⁽¹⁾
12, 27	N/C	No internal connection; May be grounded on PCB or left open
13	GND	Internally connected to GND. May be grounded on the PCB or left open
18	RF OUT	RF output, matched to 50 ohms
20	VDET	Detector diode output voltage. Varies with RF output power
23	VREF	Reference diode output voltage
24	VD3	Stage 3 drain voltage ⁽¹⁾
25	VD2	Stage 2 drain voltage ⁽¹⁾
26	VD1	Stage 1 drain voltage ⁽¹⁾

(1) Bias bypass network is required; see 'Application Circuit' on page 9 as an example.

Application Circuit

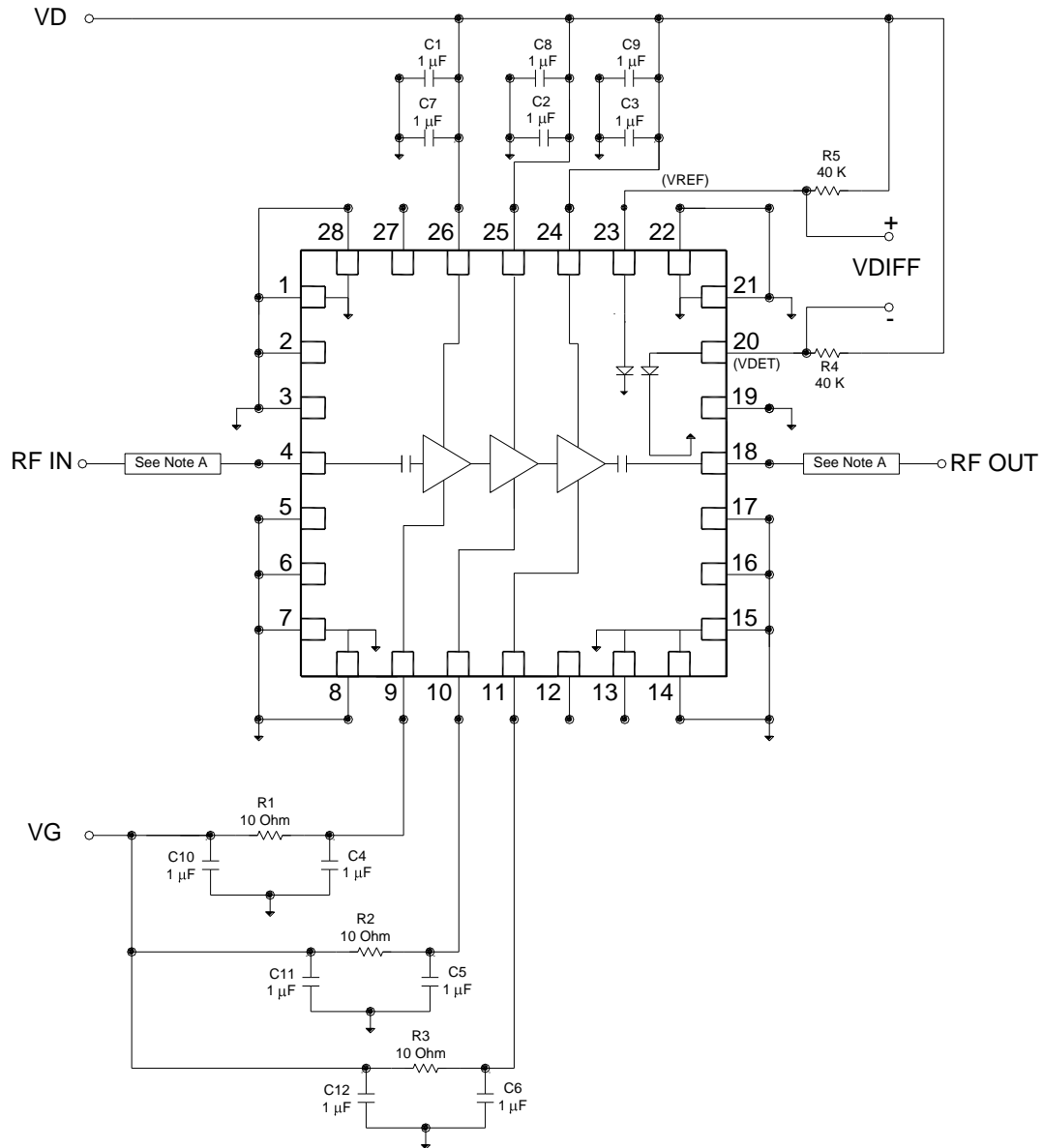

Note A: 50 Ω Microstrip Transmission Line

Bias-up Procedure	Bias-down Procedure
Vg set to -1.5 V	Turn off RF supply
Vd set to +6 V	Reduce Vg to -1.5 V. Ensure Id ~ 0 mA
Adjust Vg more positive until quiescent Id is 1430 mA. This will be ~ Vg = -0.7 V typical	Turn Vd to 0 V
Apply RF signal to RF Input	Turn Vg to 0 V

Application Circuit

PC Board Layout

Board material is Rogers Corp. 4003 0.008" thickness with 1/2 oz copper cladding.
 For further technical information, refer to the [TGA4536-SM](#) Product Information page.

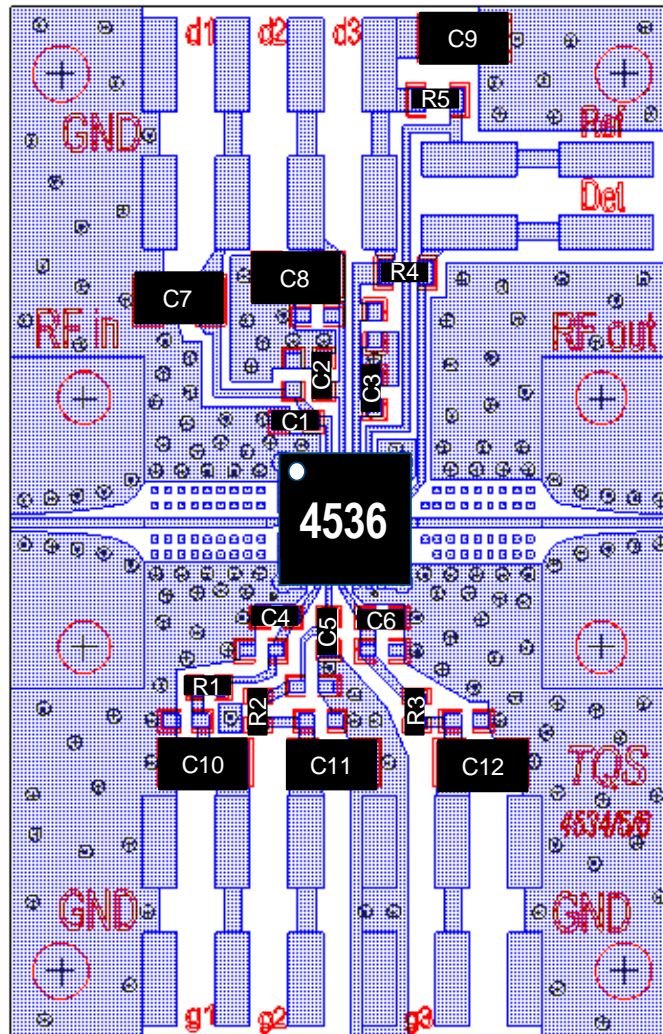

Bill of Material

Ref Des	Value	Description	Manufacturer	Part Number
U1		K Band Power Amplifier	TriQuint	TGA4536-SM
C1 thru C6	1.0 μ F	Cap, 0402, 25 V, 10%, X5R SMD	various	
C7 thru C12	1.0 μ F	Cap, 0805, 25 V, 10%, X5R SMD	various	
R1,R3,R3	10 Ω	Res, 0402, 0.06 W, 5%, SMD	various	
R4,R5	40 k Ω	Res, 0402, 0.06 W, 5%, SMD	various	

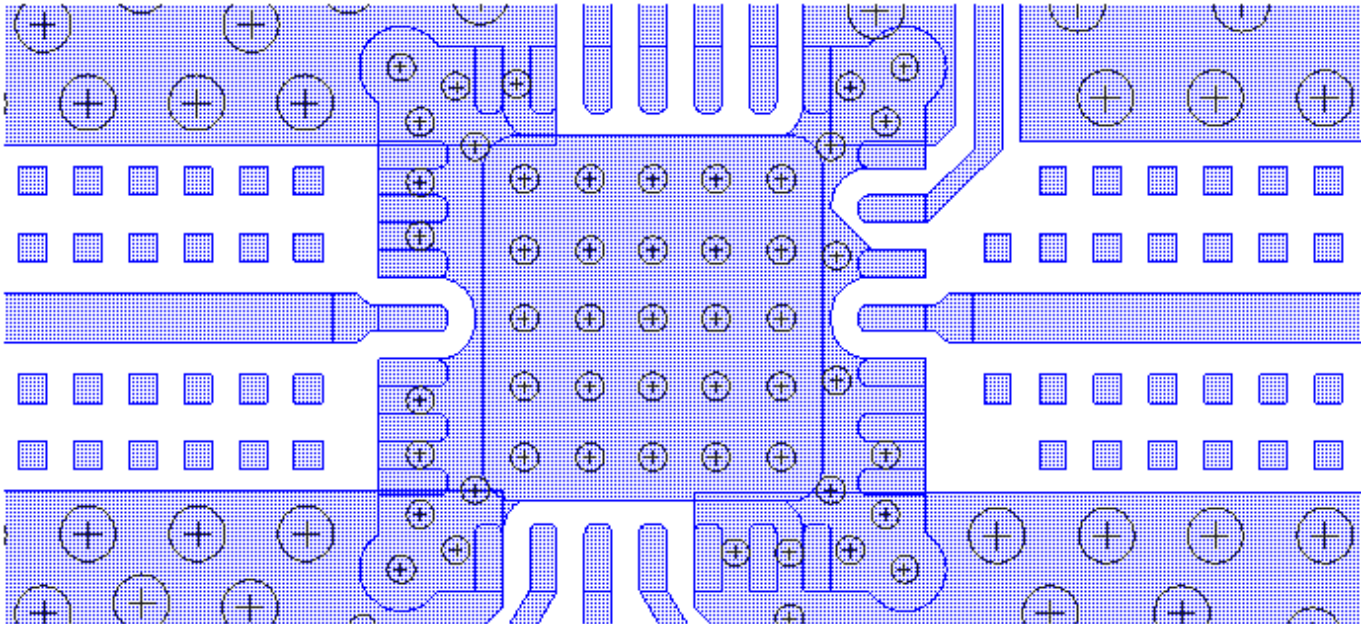
Mechanical Information**PCB Mounting Pattern****Notes:**

1. The pad pattern shown has been developed and tested for optimized assembly at TriQuint Semiconductor. The PCB land pattern has been developed to accommodate lead and package tolerances. Since surface mount processes vary from company to company, careful process development is recommended.
2. Ground vias are critical for the proper performance of this device. Vias have a final plated thru diameter of .25 mm (.010").

Tape and Reel Information

Standard T/R size = 500 pieces on a 7" reel

Vendor: Tek-Pak P/N QFN0500x0500F-L500

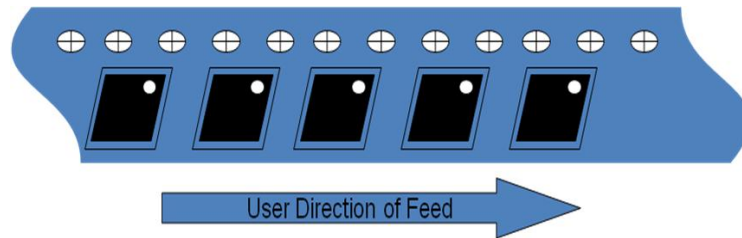

CARRIER AND COVER TAPE DIMENSIONS

Part	Feature	Symbol	Size (in)	Size (mm)
Cavity	Length	A0	0.209	5.3
	Width	B0	0.209	5.3
	Depth	K0	0.064	1.65
	Pitch	P1	0.315	8.00
Cover Tape	Width	C	0.362	9.2
Carrier Tape	Width	W	0.472	12.00

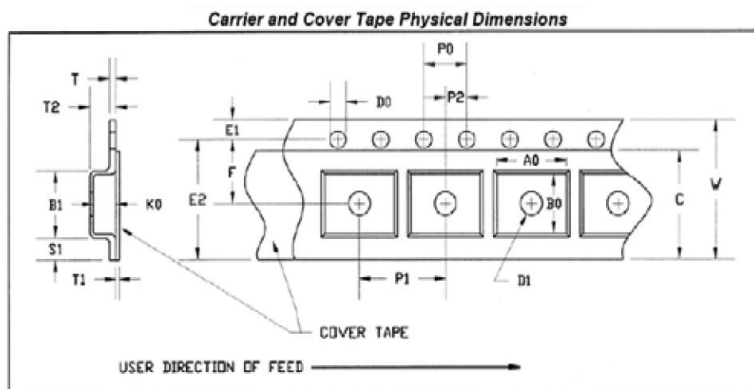

Product Compliance Information

ESD Sensitivity Ratings



Caution! ESD-Sensitive Device

ESD Rating: Class 0
 Value: ≥ 200 V and < 250 V
 Test: Human Body Model (HBM)
 Standard: JEDEC Standard JESD22-A114

MSL Rating

MSL Rating: Level 3
 Test: 260°C convection reflow
 Standard: JEDEC Standard IPC/JEDEC J-STD-020

Solderability

Compatible with lead-free (260°C maximum reflow temperature).

Package lead plating: NiPdAu.

The use of no-clean solder to avoid washing after soldering is recommended.

This package is not compatible with solder containing lead.

RoHS Compliance

This part is compliant with EU 2002/95/EC RoHS directive (Restrictions on the Use of Certain Hazardous Substances in Electrical and Electronic Equipment).

This product also has the following attributes:

- Lead Free
- Halogen Free (Chlorine, Bromine)
- Antimony Free
- TBBP-A (C₁₅H₁₂Br₄O₂) Free
- PFOS Free
- SVHC Free

Recommended Solder Temperature Profile

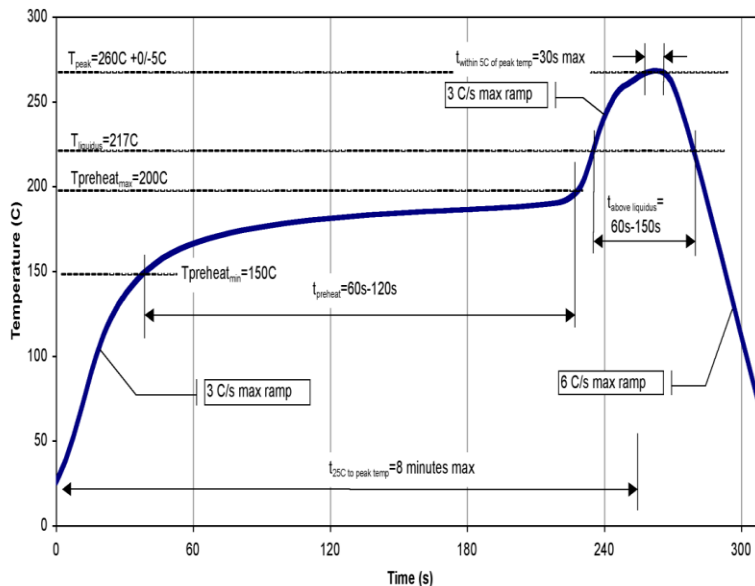

Contact Information

For the latest specifications, additional product information, worldwide sales and distribution locations, and information about TriQuint:

Web: www.triquint.com
Email: info-sales@triquint.com

Tel: +1.972.994.8465
Fax: +1.972.994.8504

For technical questions and application information:

Email: info-networks@triquint.com

Important Notice

The information contained herein is believed to be reliable. TriQuint makes no warranties regarding the information contained herein. TriQuint assumes no responsibility or liability whatsoever for any of the information contained herein. TriQuint assumes no responsibility or liability whatsoever for the use of the information contained herein. The information contained herein is provided "AS IS, WHERE IS" and with all faults, and the entire risk associated with such information is entirely with the user. All information contained herein is subject to change without notice. Customers should obtain and verify the latest relevant information before placing orders for TriQuint products. The information contained herein or any use of such information does not grant, explicitly or implicitly, to any party any patent rights, licenses, or any other intellectual property rights, whether with regard to such information itself or anything described by such information.

TriQuint products are not warranted or authorized for use as critical components in medical, life-saving, or life-sustaining applications, or other applications where a failure would reasonably be expected to cause severe personal injury or death.