

General Description

Qorvo’s QPL1000 is a packaged, high-performance, low noise amplifier fabricated on Qorvo’s production 0.25 μm , GaN (Gen II) process. Covering 8 – 11 GHz frequency range, the QPL1000 provides 27 dB small signal gain and a low noise figure of 1.7 dB. Using GaN Gen II technology, it can withstand up to 5W of CW RF incident power, delivering a saturation power of 15 dBm with a low IM3 levels of -24 dBc (at $P_{\text{out}} = +6$ dBm / tone).

Packaged in a small 4 mm x 4 mm plastic overmold QFN, the QPL1000 is matched to 50 ohms with integrated DC blocking caps on both I/O ports for easy handling and simple system integration.

The QPL1000 high performance and compact size make it ideal for satellite and point to point communication systems.

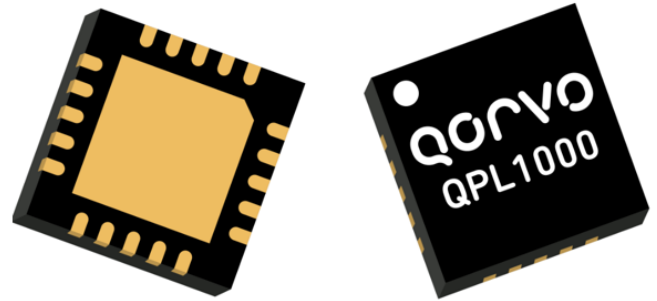

Product Features

- Frequency Range: 8 – 11 GHz
- Noise Figure: 1.7 dB
- Small Signal Gain: 27 dB
- Saturation Power: 15 dBm
- IMD3: -24 dBc (@ $P_{\text{out}} = 6$ dBm/tone)
- Bias: $V_D = 10$ V, $I_{DQ} = 20$ mA, $V_G = -2.5$ V
- Robustness: 37 dBm CW Pin.
- Plastic Over-mold Package
- Package Dimensions: 4.0 x 4.0 x 0.85 mm

*Performance is typical across frequency.
Please reference electrical specification table and data plots for more details.*

Applications

- Satellite Communications
- Point to Point Communications

Functional Block Diagram

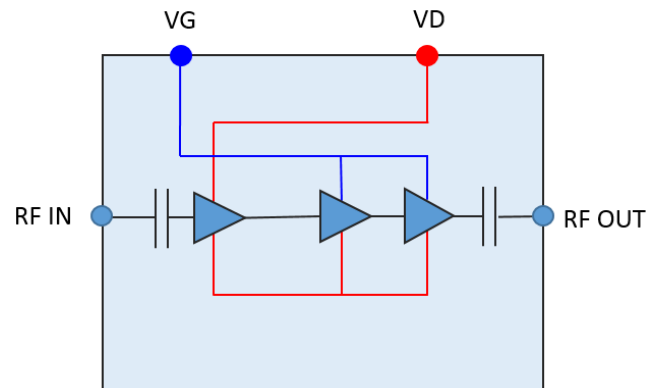

Ordering Information

Part No.	Description
QPL1000SR	QPL1000 Tape and Reel, Qty 100
QPL1000EVB	QPL1000 LNA Evaluation Board

Recommended Operating Conditions

Parameter	Value
Drain Voltage	10 V
Drain Current (quiescent, IDQ)	20 mA
Gate Voltage (typical)	-2.5 V
Operating Temperature Range	-40 to 95 °C

Electrical specifications are measured at specified test conditions. Specifications are not guaranteed over all recommended operating conditions.

Electrical Specifications

Test conditions, unless otherwise noted: VD = 10 V, IDQ = 20 mA, 25 °C. Data de-embedded to device reference planes.

Parameter	Min	Typical	Max	Units
Frequency	8		11	GHz
Small Signal Gain		27		dB
Noise Figure		1.7		dB
Power 1- dB Compression Point		9		dBm
Saturation Power		15		dBm
Input Return Loss		13		dB
Output Return Loss		12		dB
3 RD Order Intermodulation level (Pout= + 6 dBm / tone)		-24		dBc
Output TOI (Pout= + 6 dBm / tone)		18		dBm
Gain Temperature Coefficient		-0.038		dB/°C

Performance Plots – Small Signal

Test Conditions unless otherwise stated: $V_D = 10\text{ V}$, $I_{DQ} = 20\text{ mA}$, $25\text{ }^\circ\text{C}$

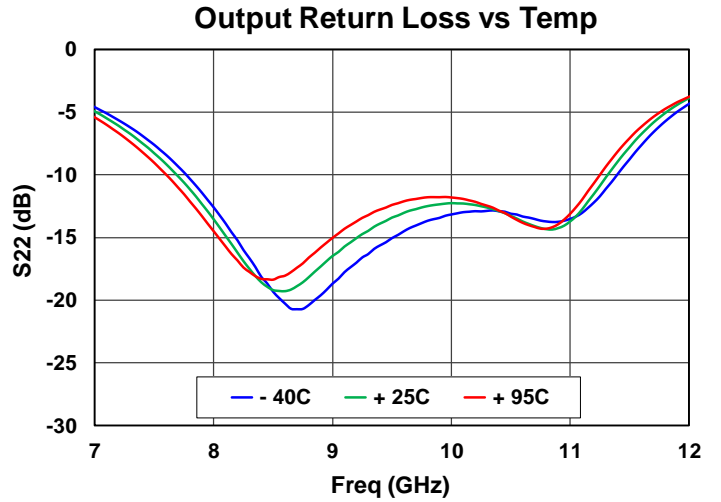
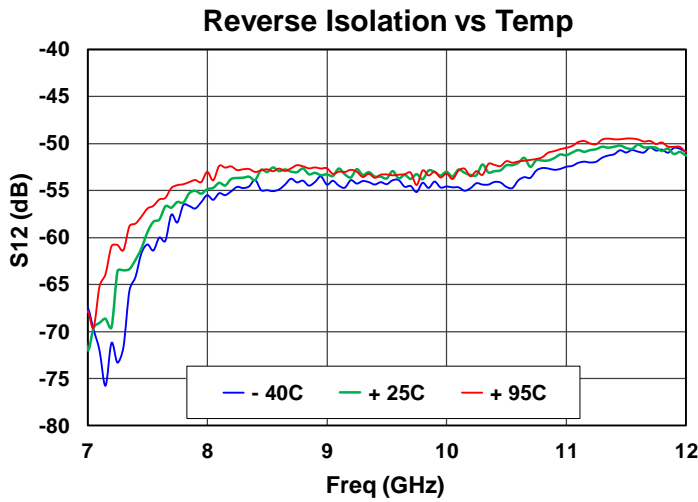
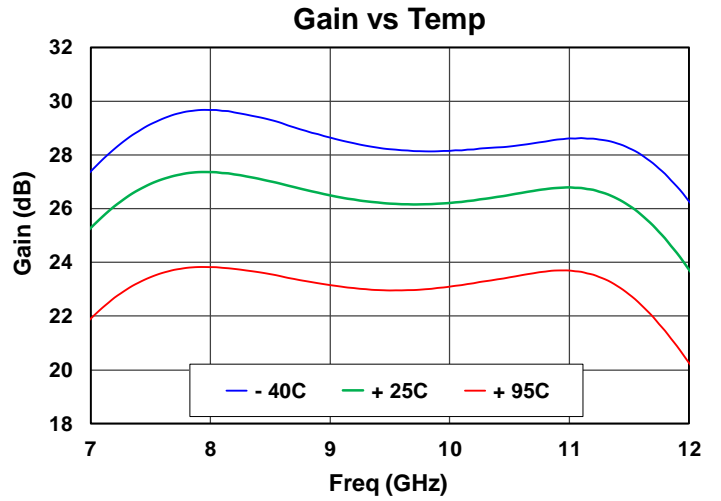
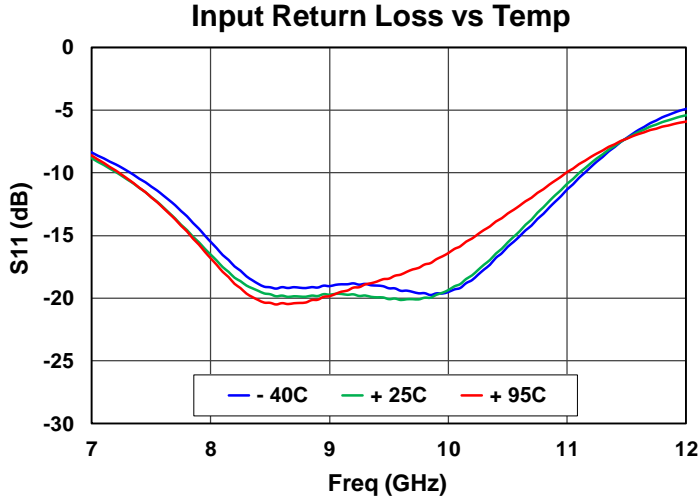

Performance Plots – Small Signal

Test Conditions unless otherwise stated: $V_D = 10\text{ V}$, $I_{DQ} = 20\text{ mA}$, $25\text{ }^\circ\text{C}$

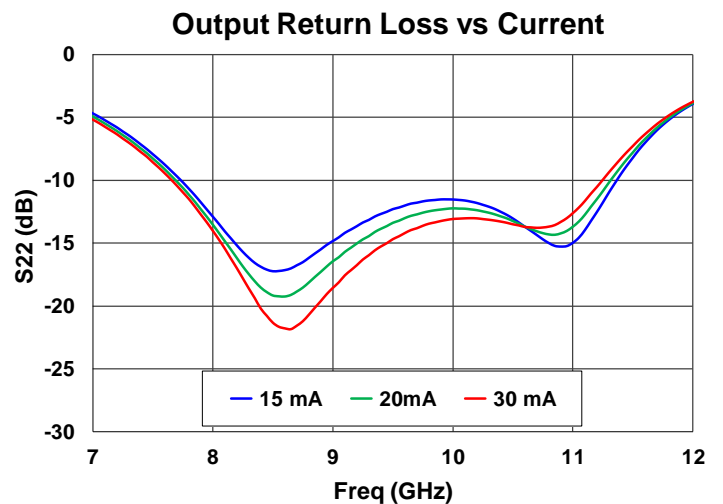
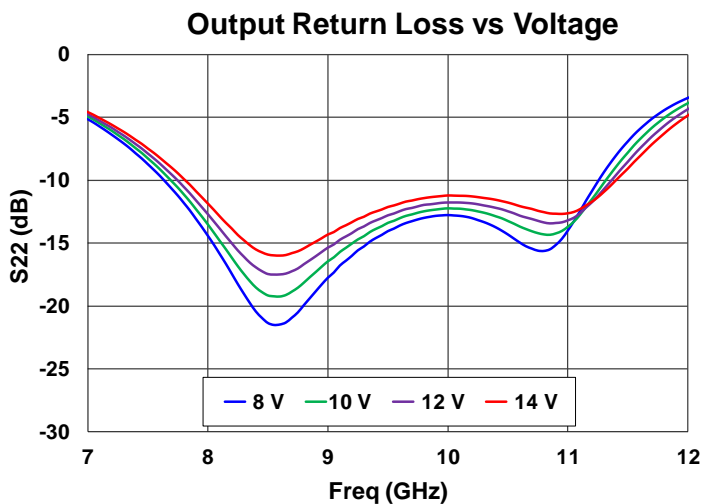
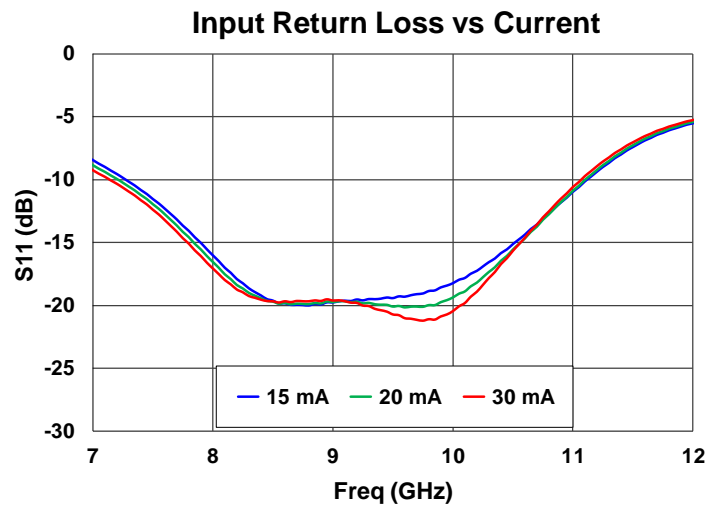
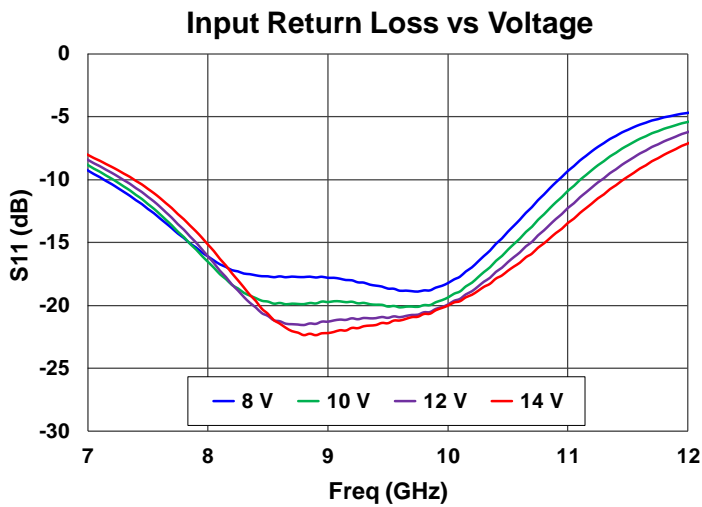
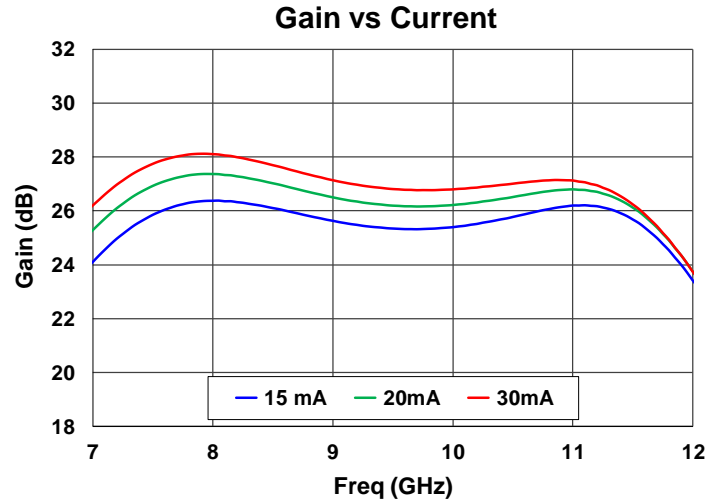
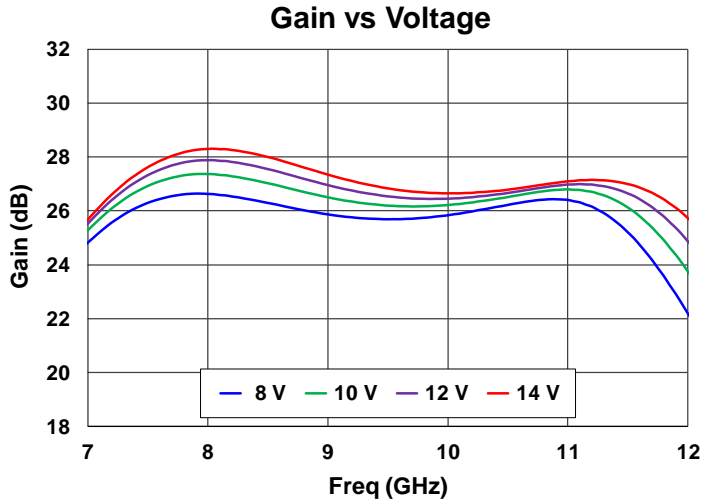

Performance Plots – Noise Figure

Test Conditions unless otherwise stated: $V_D = 10\text{ V}$, $I_{DQ} = 20\text{ mA}$, $25\text{ }^\circ\text{C}$

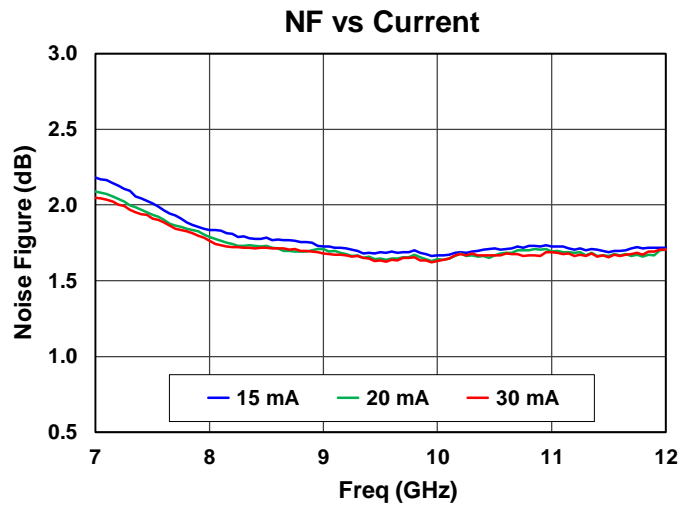
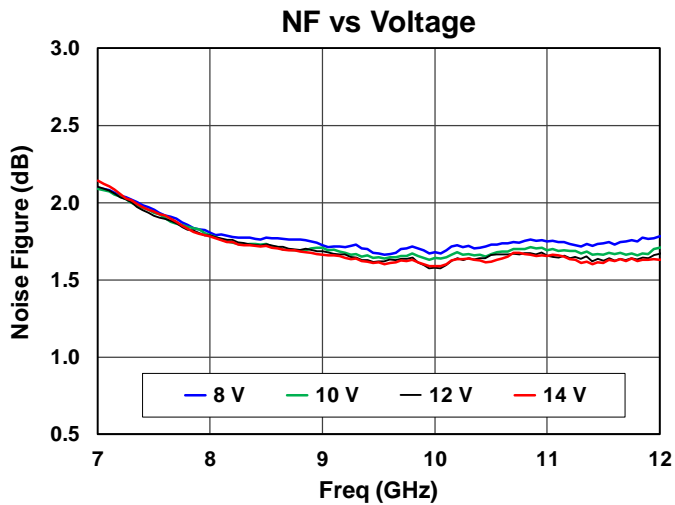
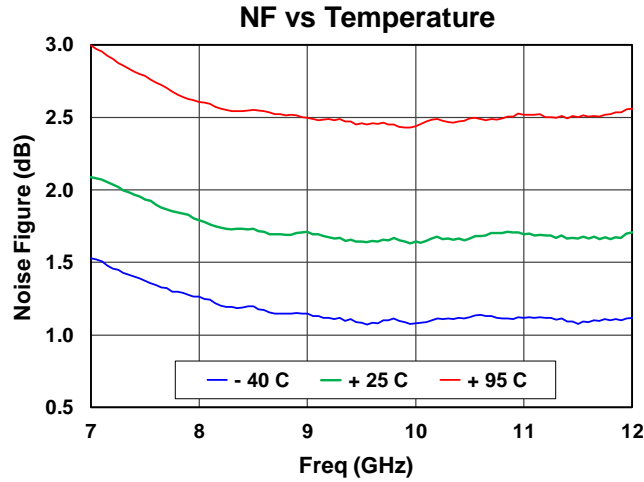

Performance Plots – Power

Test Conditions unless otherwise stated: $V_D = 10\text{ V}$, $I_{DQ} = 20\text{ mA}$, $25\text{ }^\circ\text{C}$

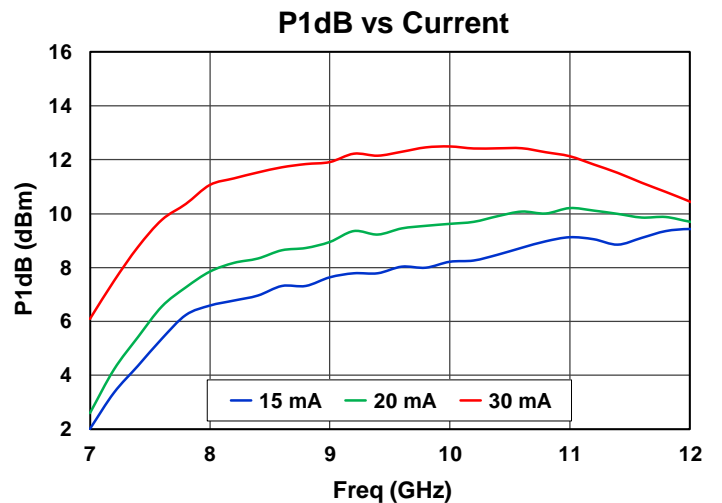
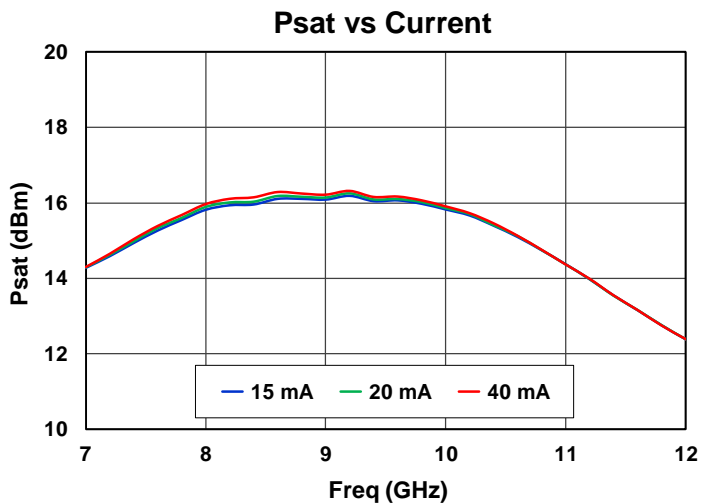
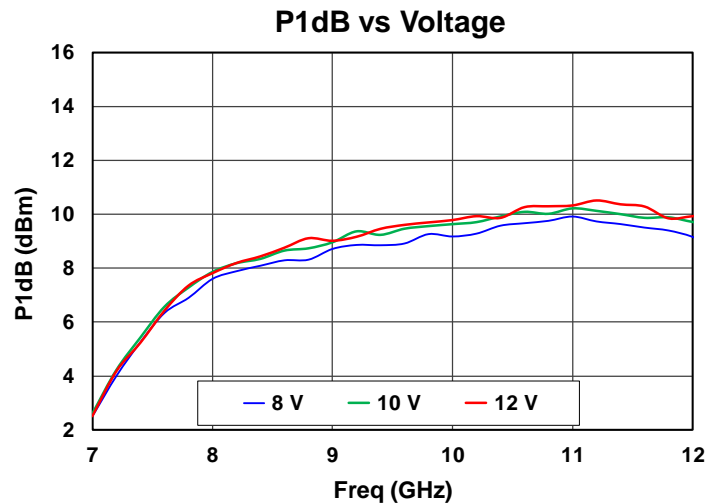
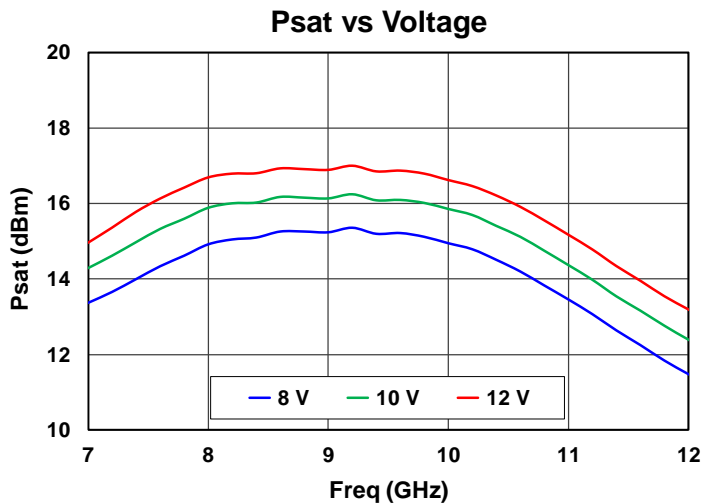
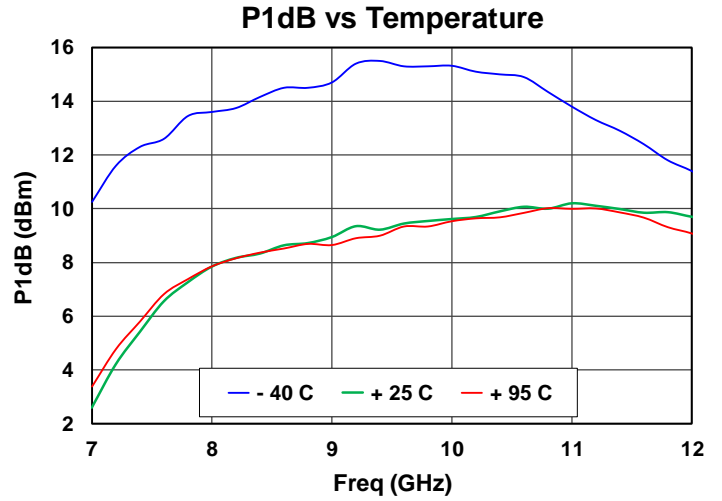
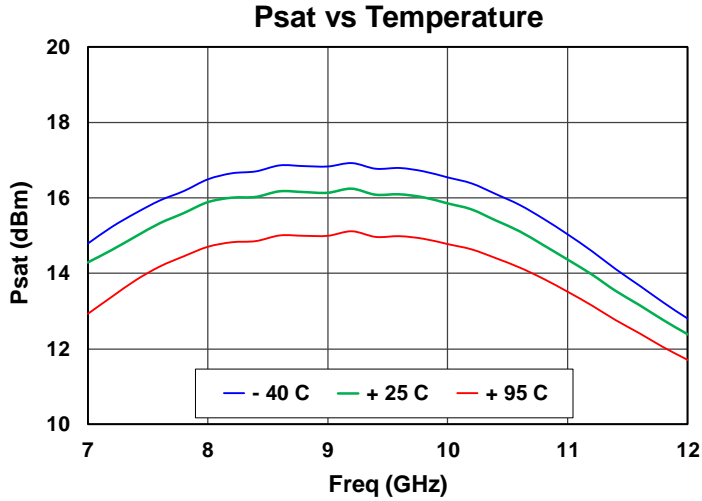

Performance Plots – Power Sweep

Test Conditions unless otherwise stated: $V_D = 10\text{ V}$, $I_{DQ} = 20\text{ mA}$, $25\text{ }^\circ\text{C}$

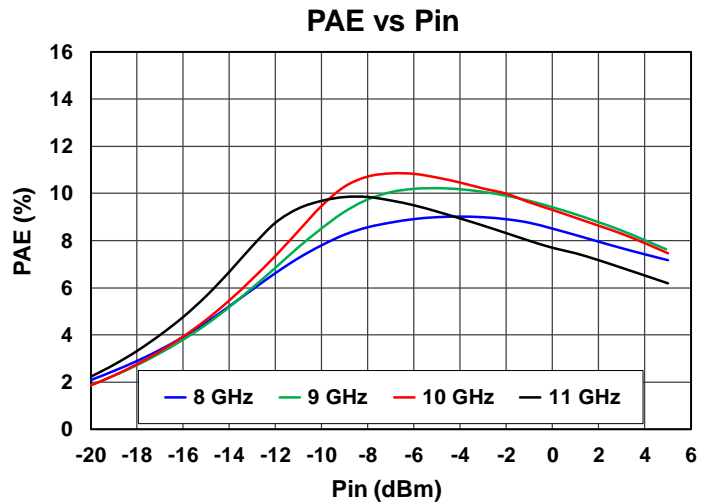
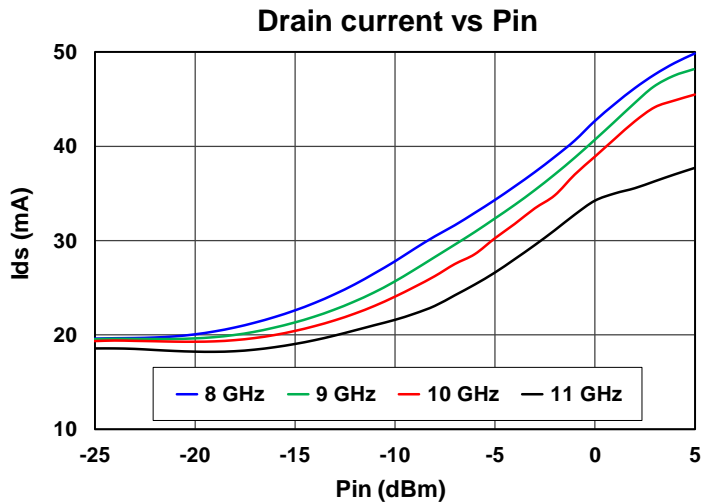
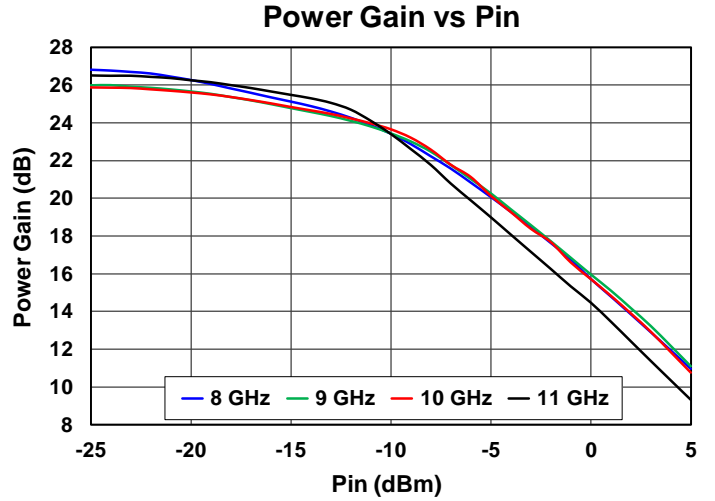
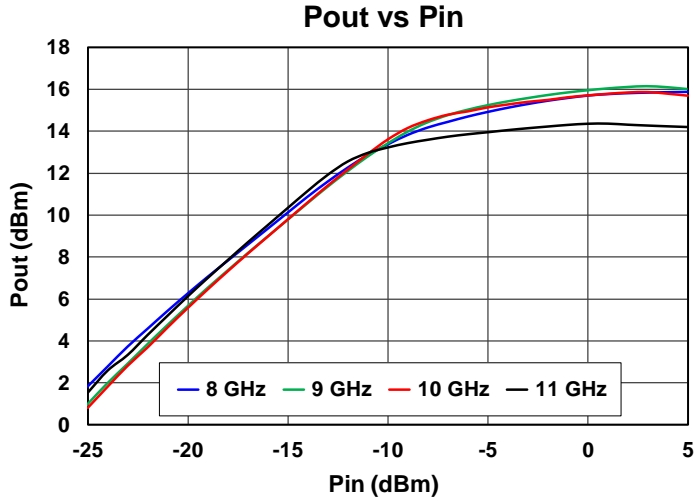

Performance Plots – Linearity

Test Conditions unless otherwise stated: $V_D = 10\text{ V}$, $I_{DQ} = 20\text{ mA}$, Tone Spacing = 10 MHz, $25\text{ }^\circ\text{C}$.

Output TOI vs Temp

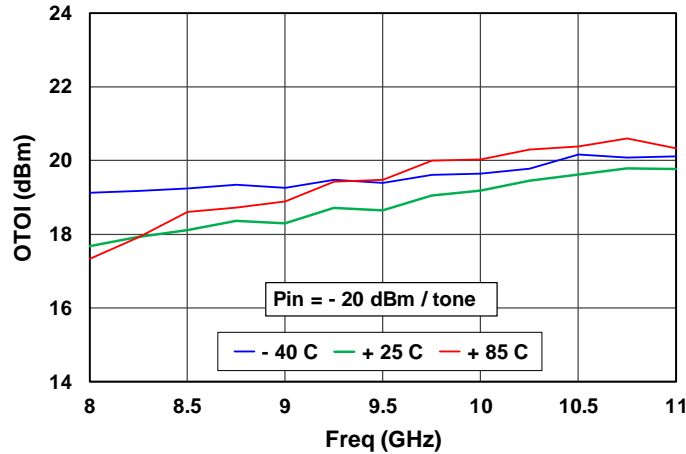

Output TOI vs Voltage

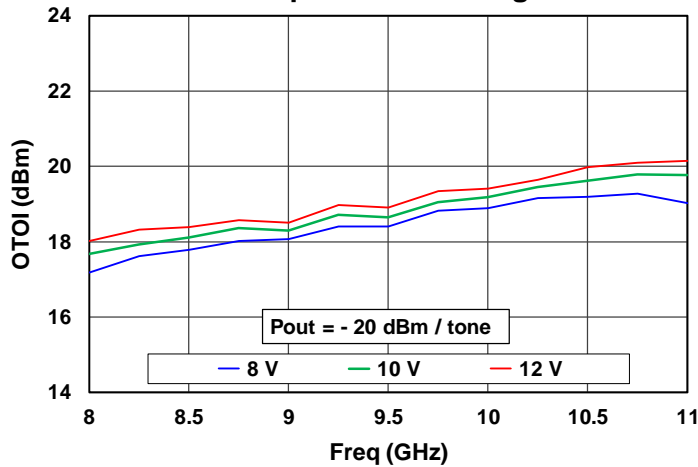

Output TOI vs Current

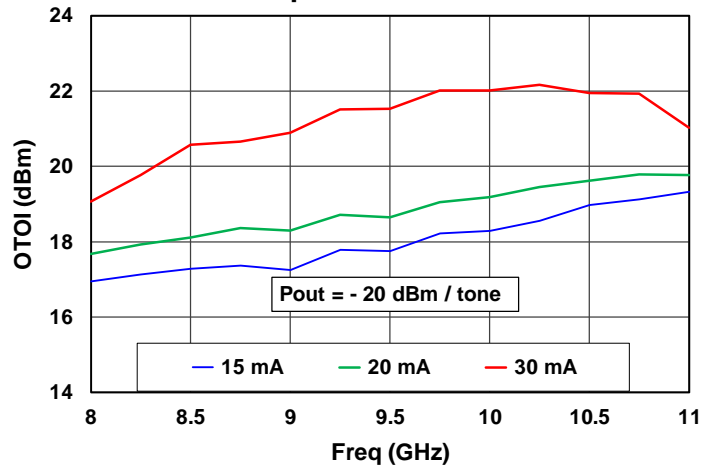

IMD3 vs Pout

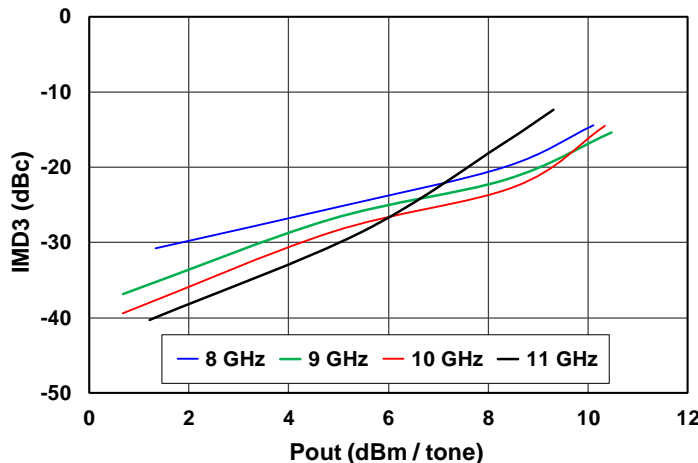

IMD5 vs Pout

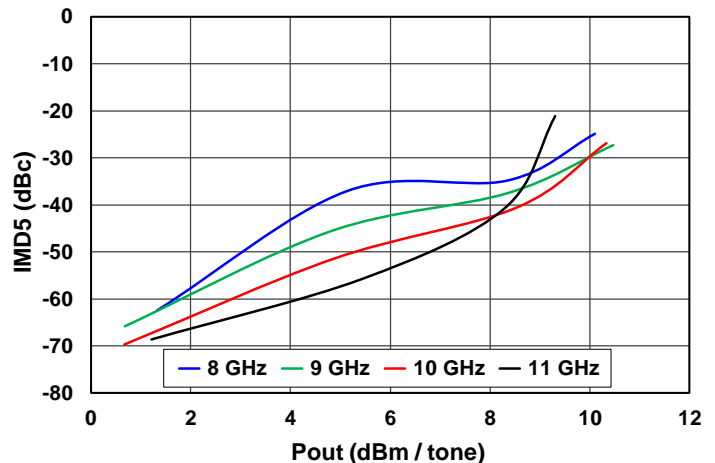

Mechanical Drawing & Pad Description

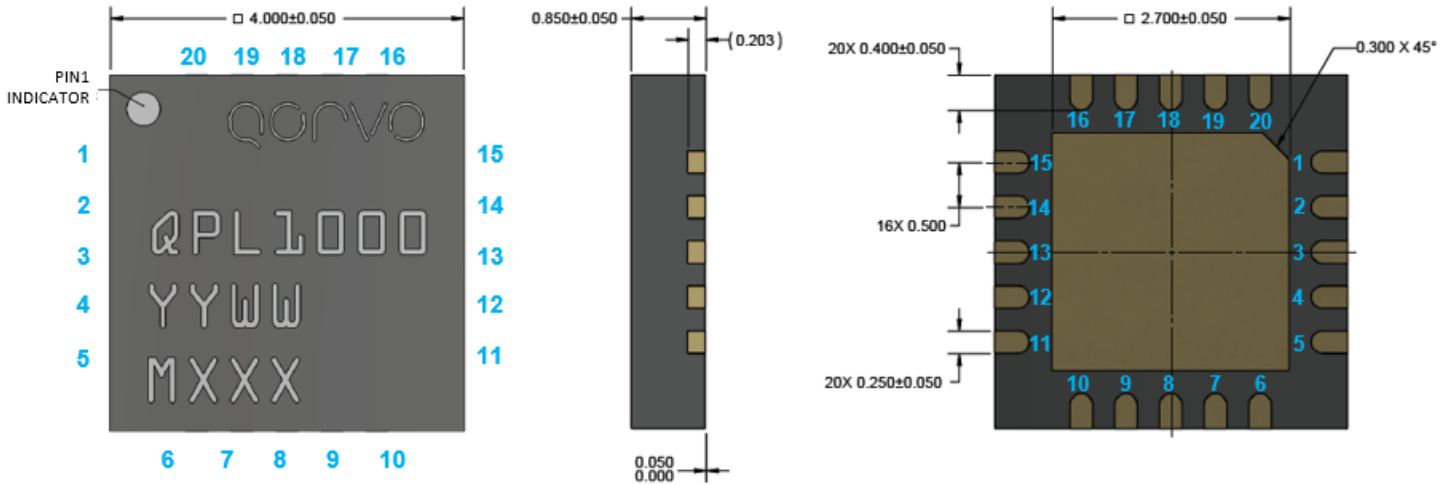

Dimensions in mm, Package Exposed Metallization is Gold Plated, Part is Overmold Encapsulated
 Part Marking: 1000: Part Number, YY = Part Assembly Year
 WW = Part Assembly Week, MXXX = Batch ID

Pin Number	Label	Description
1, 2, 4 - 12	N/C	No internal connection. Recommend to ground at the PCB level
3	RF Input	Matched to 50 ohms, DC blocked
13	RF Output	Matched to 50 ohms, DC blocked
17	VD	Drain Voltage
18	VG	Gate Control
14 -16, 19 -20	N/C	No internal connection. Recommend to GND at the PCB level
Ground Pad	GND	GND

Application Circuit

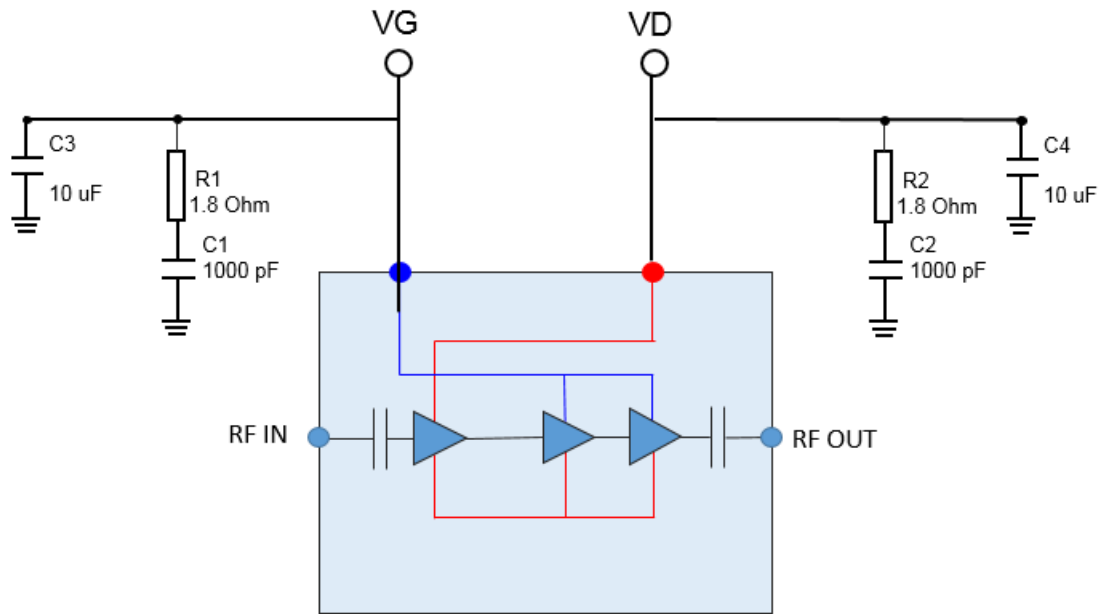

Bias-up Procedure

1. Set ID limit to 50 mA, IG limit to 10 mA
2. Set VG to - 5 V
3. Set VD + 10 V
4. Adjust VG more positive until $I_{DQ} = 20$ mA (VG ~ - 2.5 V Typical)
5. Apply RF signal

Bias-down Procedure

1. Turn off RF signal
2. Reduce VG to - 5 V. Ensure $I_{DQ} \sim 0$ mA
3. Set VD to 0V
4. Turn off VD supply
5. Turn off VG supply

Evaluation Board and Assembly

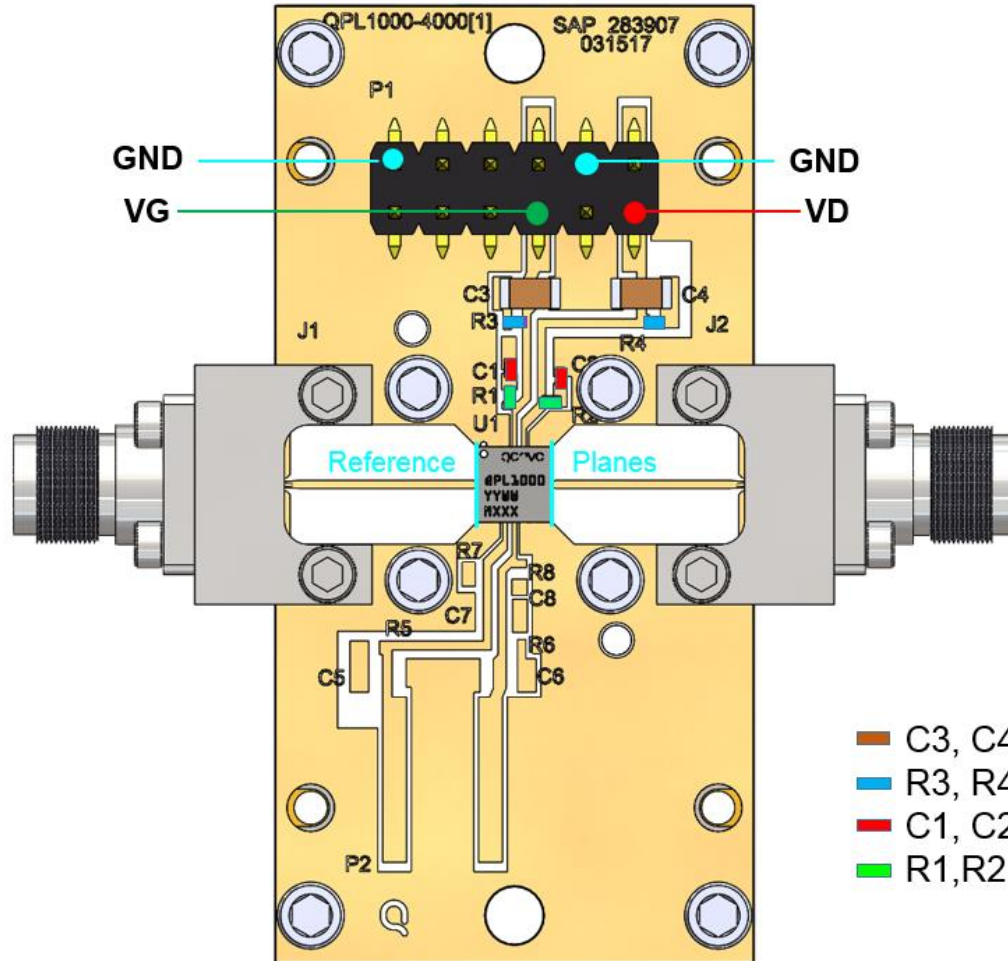

RF Layer is 0.008" thick Rogers Corp. RO4003C ($\epsilon_r = 3.35$). Metal layers are 0.5 oz. copper. The microstrip line at the connector interface is optimized for the Southwest Microwave end launch connector 1092-01A-5.

Bill of Materials

Ref. Des.	Component	Value	Manuf.	Part Number
C1, C2	Surface Mount Cap.	CAP 1000 pF +/-10% 50 V 0402 X7R ROHS	Various	
C3, C4	Surface Mount Cap.	CAP 10 uF +/-20% 50 V 1206 X5R ROHS	Various	
R1, R2	Surface Mount Cap.	RES 1.8 Ohm, 5% 1/10 W, 0402, ROHS	Various	
R3, R4	Surface Mount Ind.	RES 0 Ohm, JMPR, 0402	Various	

Absolute Maximum Ratings

Parameter	Value
Drain Voltage (VD)	40 V
Drain Current (ID1/ID2/ID3)	50 mA
Gate Voltage Range	-8 to 0 V
Gate Current (125 °C)	10 mA
RF Input Power (50 Ω, 85 °C)	37 dBm
Channel Temperature, T _{CH}	175 °C
Mounting Temperature (30 seconds)	260 °C
Storage Temperature	- 55 to 150 °C

Operation of this device outside the parameter ranges given above may cause permanent damage. These are stress ratings only, and functional operation of the device at these conditions is not implied. Extended application of Absolute Maximum Rating conditions may reduce device reliability.

Thermal and Reliability Information

Parameter	Values	Units	Conditions
Small Signal, Thermal Resistance (θ_{JC}) ^(1,2,3)	18.20	°C/W	Quiescent/Small signal operation T _{base} = 85°C, V _D = 10 V, I _{DQ} = 20 mA P _{DISS} = 0.2 W
Channel Temperature (T _{CH})	88.64	°C	
Under Drive, Thermal Resistance (θ_{JC}) ^(1,2,3)	25.44	°C/W	Under RF drive to saturation T _{base} = 85°C, V _D = 10 V, RFIN = 5 dBm, I _{DS} = 43.5 mA P _{DISS} = 0.41 W
Channel Temperature (T _{CH})	95.43	°C	

Notes:

1. Thermal resistance is measured to package backside
2. Base or ambient temperature is 85 °C
3. Refer to the following document: [GaN Device Channel Temperature, Thermal Resistance, and Reliability Estimates](#)

Solderability

- Compatible with the latest version of J-STD-020, Lead-free solder, peak reflow temperature 260 °C.

Recommended Soldering Temperature Profile

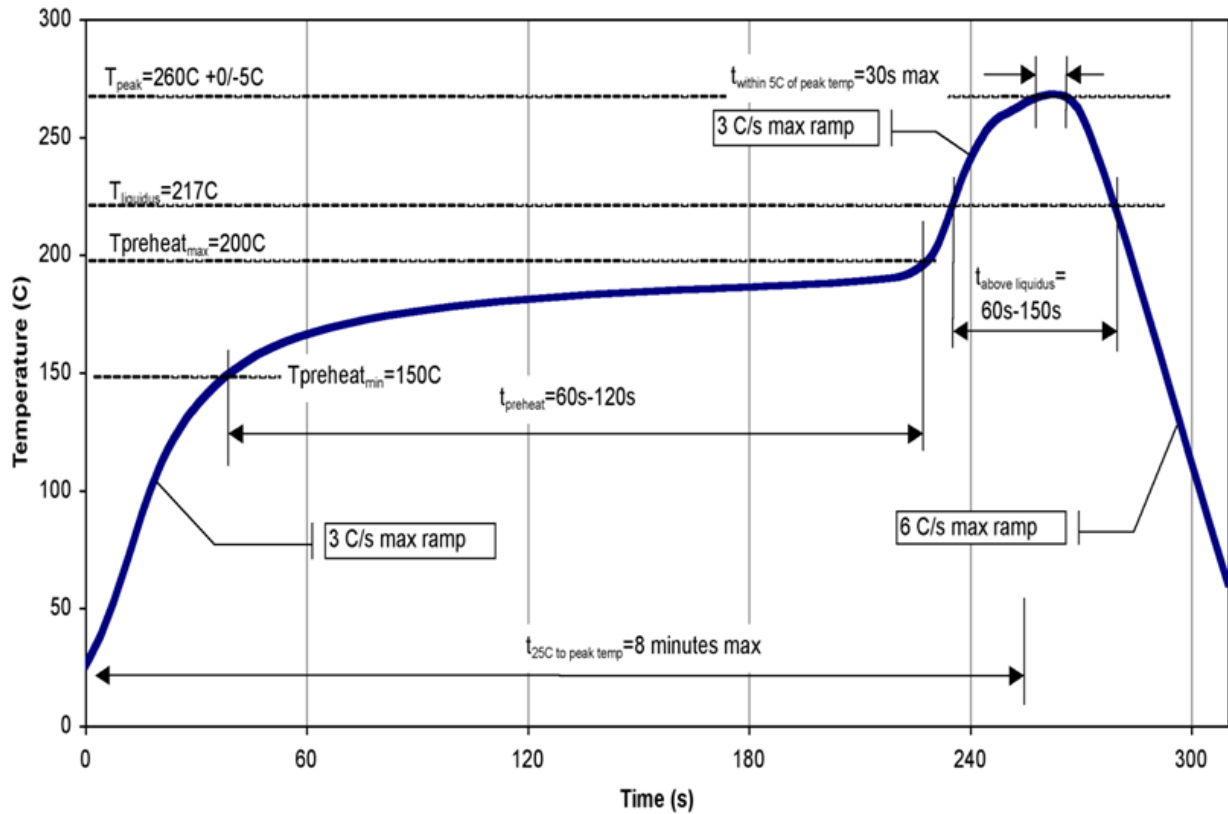

Handling Precautions

Parameter	Rating	Standard
ESD – Human Body Model (HBM)	0B	ESDA / JEDEC JS-001-2012
ESD – Charged Device Model (CDM)	C3	ESDA / JEDEC JS-002-2014
MSL – Convection Reflow 260 °C	3	JEDEC standard IPC/JEDEC J-STD-020



Caution!
ESD-Sensitive Device

RoHS Compliance

This product is compliant with the 2011/65/EU RoHS directive (Restrictions on the Use of Certain Hazardous Substances in Electrical and Electronic Equipment), as amended by Directive 2015/863/EU.

This product also has the following attributes:

- Lead Free
- Halogen Free (Chlorine, Bromine)
- Antimony Free
- TBBP-A (C₁₅H₁₂Br₄O₂) Free
- SVHC Free

Contact Information

For the latest specifications, additional product information, worldwide sales and distribution locations:

Tel: 1-844-890-8163

Web: www.qorvo.com

Email: customer.support@qorvo.com

Important Notice

The information contained herein is believed to be reliable; however, Qorvo makes no warranties regarding the information contained herein and assumes no responsibility or liability whatsoever for the use of the information contained herein. All information contained herein is subject to change without notice. Customers should obtain and verify the latest relevant information before placing orders for Qorvo products. The information contained herein or any use of such information does not grant, explicitly or implicitly, to any party any patent rights, licenses, or any other intellectual property rights, whether with regard to such information itself or anything described by such information. **THIS INFORMATION DOES NOT CONSTITUTE A WARRANTY WITH RESPECT TO THE PRODUCTS DESCRIBED HEREIN, AND QORVO HEREBY DISCLAIMS ANY AND ALL WARRANTIES WITH RESPECT TO SUCH PRODUCTS WHETHER EXPRESS OR IMPLIED BY LAW, COURSE OF DEALING, COURSE OF PERFORMANCE, USAGE OF TRADE OR OTHERWISE, INCLUDING THE IMPLIED WARRANTIES OF MERCHANTABILITY AND FITNESS FOR A PARTICULAR PURPOSE.**

Without limiting the generality of the foregoing, Qorvo products are not warranted or authorized for use as critical components in medical, life-saving, or life-sustaining applications, or other applications where a failure would reasonably be expected to cause severe personal injury or death.

© 2021 Qorvo US, Inc. All rights reserved. This document is subject to copyright laws in various jurisdictions worldwide and may not be reproduced or distributed, in whole or in part, without the express written consent of Qorvo US, Inc.